

## Sink S1000

Kitchen Sinks

Code: 1144 002



### DETAILS

Edge/Installation Type      Standard (8 mm Edge)

---

Finish      Foster brushed

---

Material      AISI 304 stainless steel

---

Texture      Foster brushed

---

Base      45 cm

---

Dimensions      440x500 mm

---

Standard fittings      Fixing hooks, gasket, drain, overflow and siphon, boxed packing

---

Mixer holes      1 standard hole - 2nd hole on request

---

Built-in hole      420x480 mm

---

Drainer No

---

Width 44 cm

---

Bowl dimension 360x360mm

---

Number of bowls 1 bowl

---

Waste fitting 2" Drain

---

## FEATURES

**Added value** Foster uses steel thicknesses higher than those used on average by other manufacturers. This is how, thanks to our long experience, we know how to make sinks of superior quality and with a better resistance to aging.

---

**Basket 3,5" waste fitting** The drain is equipped with a large 3.5" drain, with the practical basket cap that prevents the discharge of solid parts.

---

## TECHNICAL DATA

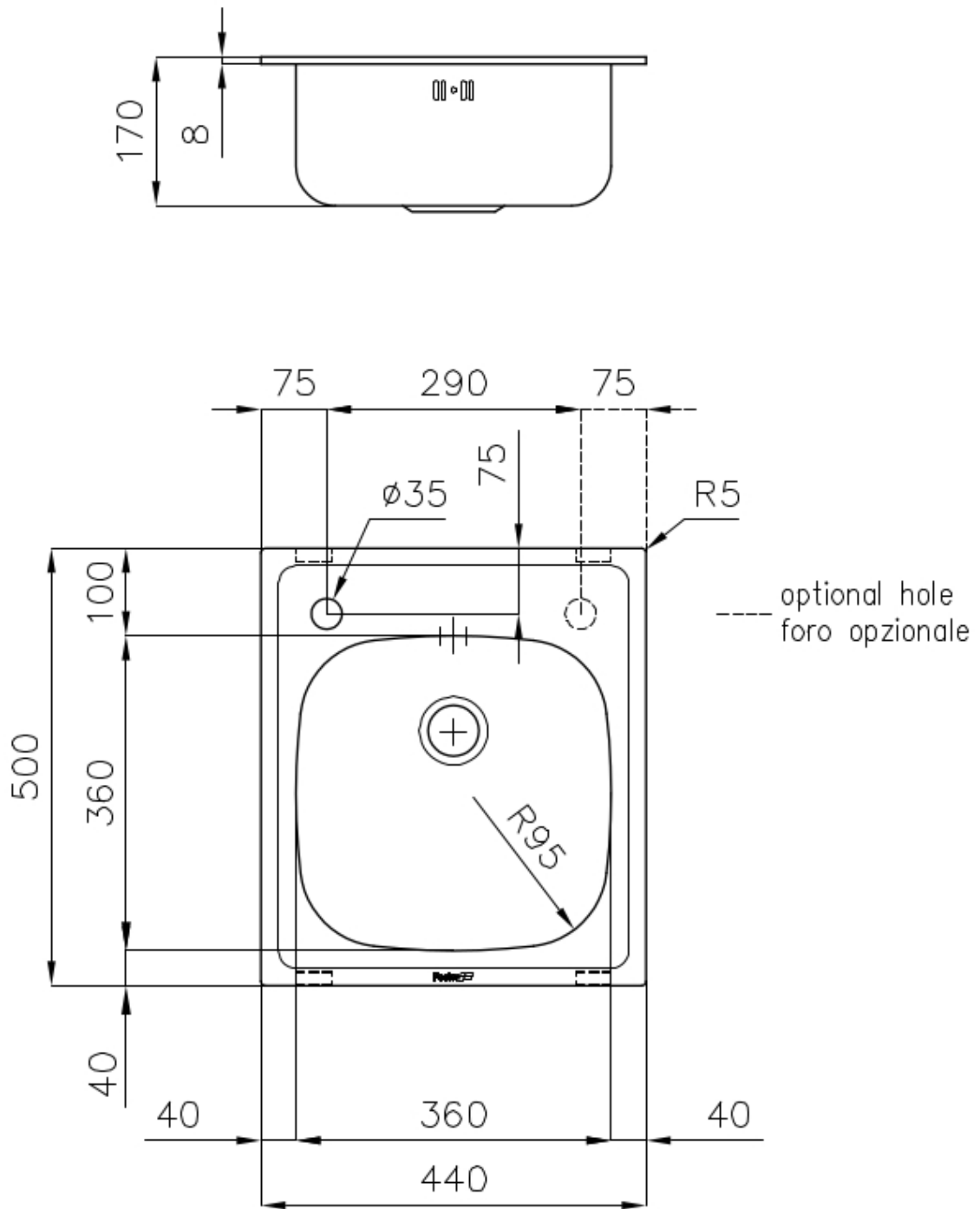

## GALLERY



## RECOMMENDED PAIRINGS



Mixer Tap Lorenzo



Mixer Tap S1000 - RO